

Data Sheet



Article number: 021500700062

Description: Sealing Clamp S 62 W5

Measures

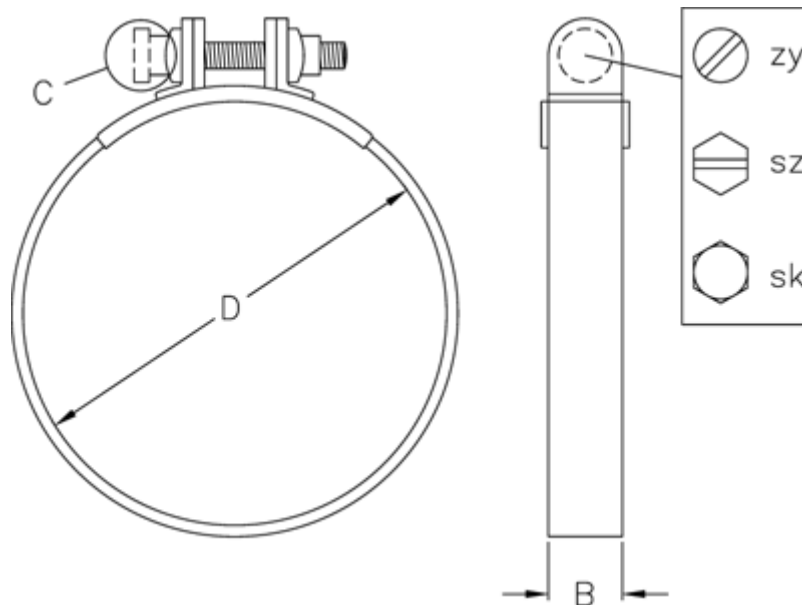

C (screw type) = SZ

Diameter D = 62

Width B = 20